













## Montage Scheinwerferverkleidung - Headlight cover instructions

6580170



NR	TEILE / PARTS	QTY	BESCHREIBUNG	DESCRIPTION
1		x1	Scheinwerferverkleidung	Headlight cover
2		x2	<i>Originalschraube</i>	<i>Original screw</i>
3		x1	Halter rechts	Right bracket
4		x1	Halter links	Left bracket
5		x2	Schraube BHc M6x35 für US & Kanada Modelle	M6x35 BHc N steel screw for US & Canada model
6		x4	Schraube BHc M5x15	M5x15 BHc N steel screw
7		x2	Kunststoffdistanz D6x20 Höhe 5 mm	Plastic spacer D6x20 thickness 5 mm
8		x4	Kunststoffdistanz D6x10 für US & Kanada Modelle	D6x10 Plastic spacer for US & Canada model
9		x4	Kunststoffunterlegscheibe L5	L5 Nylon washer
10		x4	Gewindeklemme M5	M5 Threaded clip
11		x1	Gitter 110x50 mm (für unlackierte Modelle)	110x50 mm grid (for rough headlight cover)
12		x1	Abdeckung ABS (für unlackierte Modelle)	ABS Cover (for rough headlight cover)

### 1 Montage des Gitters<sup>1</sup> Assembly of the grid<sup>1</sup>

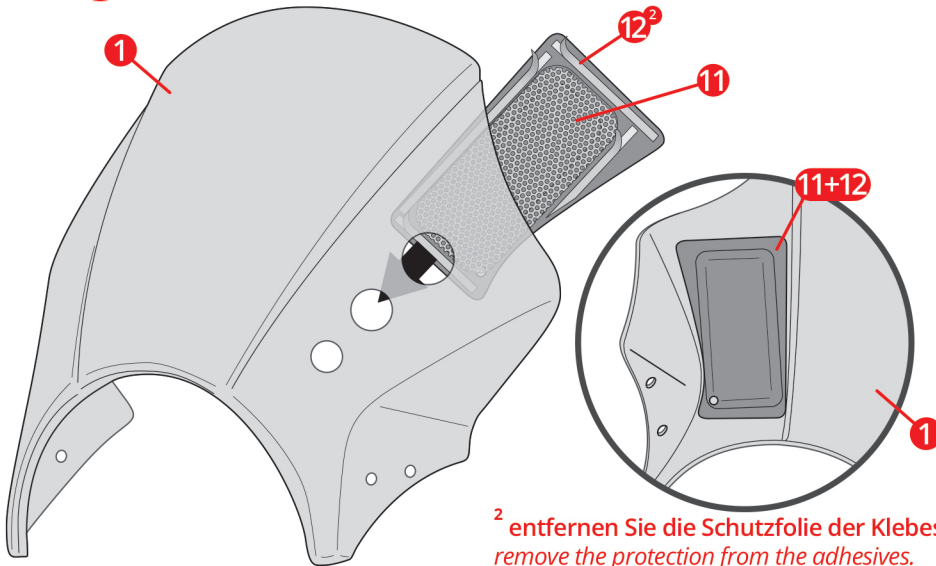

<sup>2</sup> entfernen Sie die Schutzfolie der Klebestreifen.  
remove the protection from the adhesives.

<sup>1</sup> Nur für unlackierte Modelle.  
to be assembled only for rough nose fairing.

### 2 Montage - Assembly

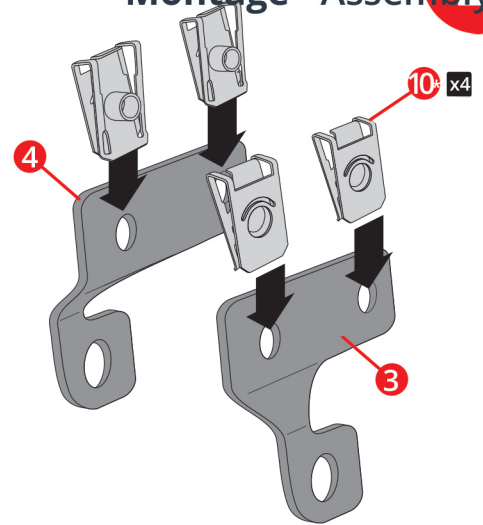

### 3 Montage - Assembly

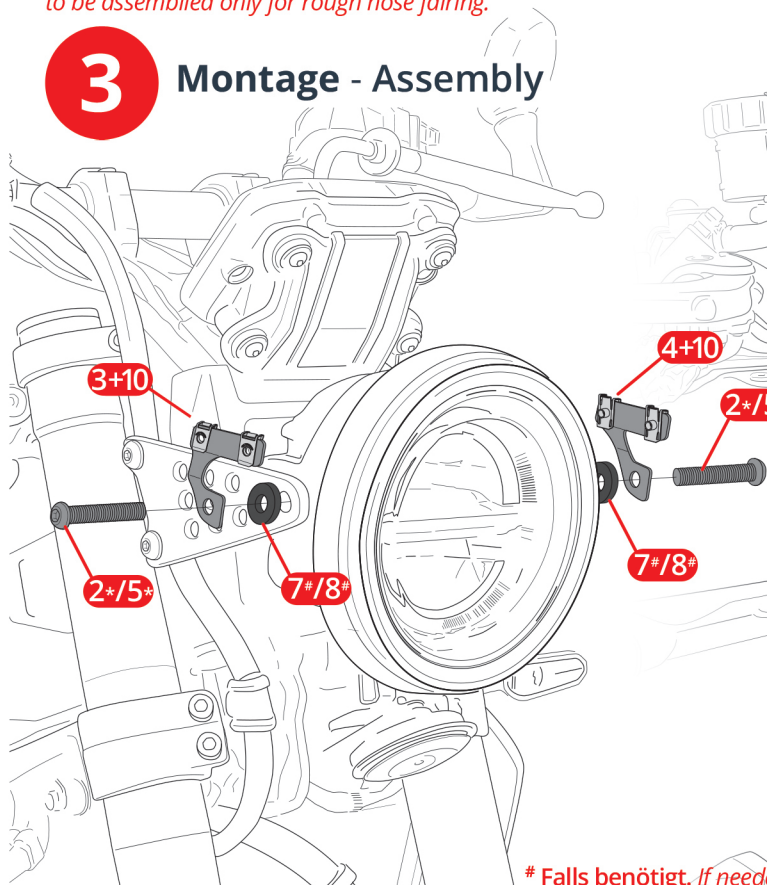

\* Falls benötigt. If needed.

\* Entfernen Sie die Schrauben Nr. 2 und 4 nicht gleichzeitig.  
do not remove the screws n°2 or 4 simultaneously.

### 4 Montage - Assembly

